

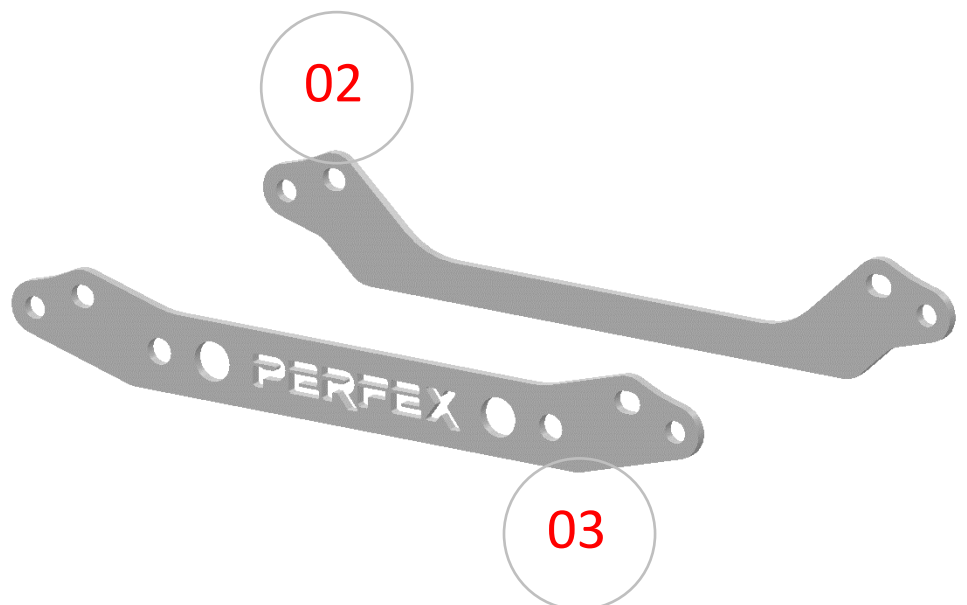

INSTALLATION INSTRUCTIONS

SKU: **LK-10296**

1.5" LIFT KIT CF MOTO CFORCE 400/500S (2016-2022)

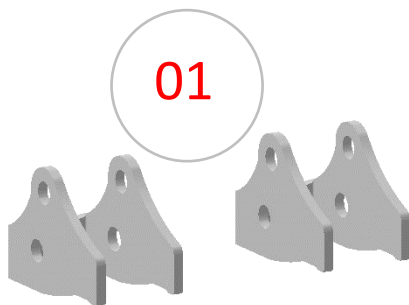

Item	Part No.	Description	Qty.
------	----------	-------------	------

LIFT COMPONENTS

Those items are shown on the first page.

01	10296-01	Front lift bracket	2
02	10296-02	Rear lift bracket	1
03	10296-03	Rear lift bracket (PERFEX Logo)	1

FRONT HARDWARE

Those items are included with each kit to install the front lift components.

05	H10-3060	M10-1.50 x 60mm Hex Flange Bolt	4
06	H10-8030	M10-1.50 Hex Flange Nylon Lock Nut	4
07	H10-9011	M10 x 20mm OD. Flat Heavy Washer	4
08	S12-1188	12mm ID. x 11/16" OD. x 1-3/16" Lg. steel spacer	2

REAR HARDWARE

Those items are included with each kit to install the rear lift components.

08	H10-3065	M10-1.50 x 65mm Hex Flange Bolt	4
09	H10-8030	M10-1.50 Hex Flange Nylon Lock Nut	4
06	H10-9011	M10 x 20mm OD. Flat Heavy Washer	4
07	S12-1250	12mm ID. x 11/16" OD. x 1-1/4" Lg. steel spacer	2

PLEASE READ AND UNDERSTAND BEFORE THE INSTALLATION

CUSTOMER AND/OR END USER:

This product is designed for use on ATVs and/or UTVs to increase ground clearance and fender clearance. Purchasers should be aware that use of this product may increase the frequency of required maintenance, part wear...

Using a lift kit will raise the center of gravity on your ATV and/or UTV, increasing risk of roll-over, injury and death on ALL types of terrain. It's YOUR RESPONSIBILITY to always inform other operators and passengers of this vehicle about the added risks.

Our products are designed to best fit user's ATV/UTV under stock conditions. Adding, modifying, or fabricating any OEM or aftermarket parts will void warranty. PERFEX Industries products could interfere with other aftermarket accessories. If the user has aftermarket products on machine, please contact PERFEX Industries to verify that they will work together.

Adding aftermarket suspension components and/or more aggressive tires can cause breakage of other OEM driveline components such as differentials, axles or drive shafts.

We ALWAYS recommend that wider tires and/or wheel spacers be used to achieve a wider stance and to improve stability of the ATV and/or UTV. Riders should be advised that the handling characteristics of a taller ATV and/or UTV are different and require extra care when riding, particularly on side hills or off-camber situations. If you further raise the center of gravity by adding taller tires, heavy loads to racks or seats, or by any other means, the ATV and/or UTV must be operated with even more care, at slower speeds and on relatively flat ground. All turns should be done at a slow speed, even on level ground.

Operation of an ATV and/or UTV with or without modified suspension components, while or shortly after consuming alcohol or drugs, subjects the rider to the risk of serious bodily harm or possible death. This risk is compounded if the rider does not wear an approved helmet and other safety gear.

PERFEX Industries urges that all approved safety gear be worn when riding an ATV and/or UTV as a driver or passenger.

By purchasing and installing PERFEX Industries products, user agrees that should damages occur, PERFEX Industries will not be held responsible for loss of time, use, labor fees, replacement parts, or freight charges. WE (PERFEX Industries) will not be held responsible for any direct, indirect, incidental, special, or consequential damages that result from any product purchased from PERFEX Industries.

PLEASE TAKE NOTE: The total liability of seller to user for all damages, losses, and causes of action, will never exceed the total purchase price paid for the product that gives rise to the claim.

DEALER AND/OR OTHER INSTALLERS:

You are responsible for informing your customer and end user of the information contained above and the increased potential hazards of operating an ATV and/or UTV equipped with modified suspension components.

If you install any suspension modifying components, it is your responsibility to also install a warning label prominently in view of the driver and in prominent view of the driver and passenger on UTVs and multi-passenger ATVs.

They should also be instructed to notify anyone operating the vehicle, as well as any passengers, that said vehicle is modified.

As discussed above, it is critically important that they be instructed in the need for slower speed operation, regardless of terrain, after this lift kit is installed.

FRONT INSTALLATION INSTRUCTIONS

PREPARATION

- Using a jack under center of front end, lift until the front wheels leave the ground.
- Remove the wheels.
- Disconnect the bottom of the shocks from the suspension arms. Use a 15mm wrench and socket.



DISCONNECT BOTH SIDES

- Remove all the dirt that is on your a-arms, on each side of the shocks mount.

INSTALLATION

1. Install one front bracket to the shock mount. Use **(1x)** M10-1.50 x 60mm bolt, **(1x)** 1-3/16" Lg. spacer and **(1x)** M10-1.50 lock nut.

NOTE: Open side on the bracket needs to be face of the tire.

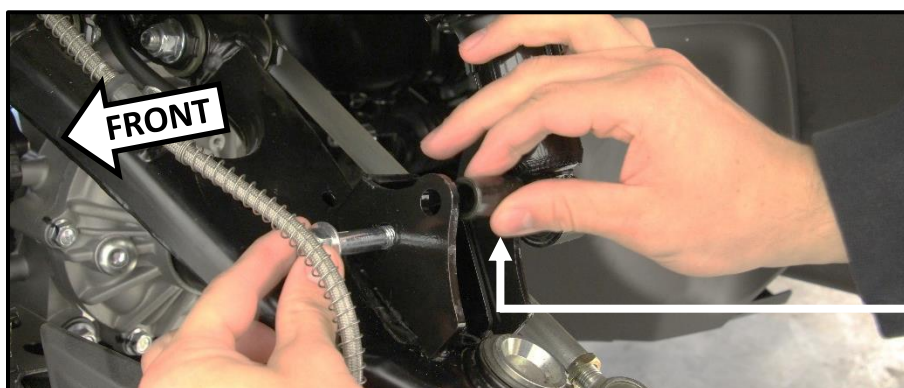
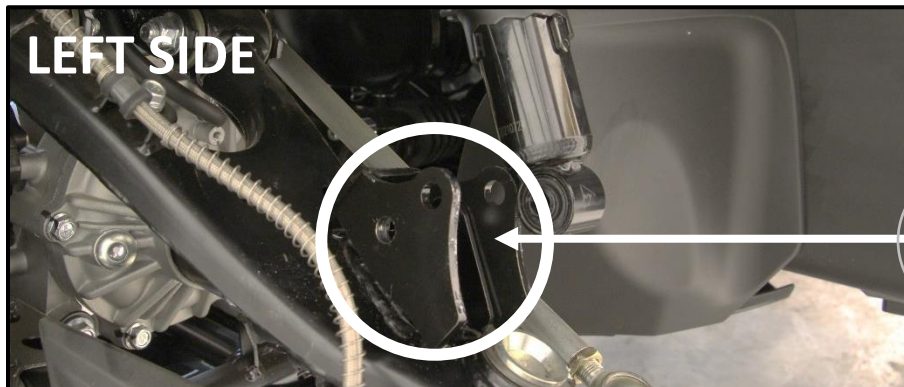

1-3/16" Lg. SPACER

2. Connect the bottom of the shock to the new shock location on the bracket. Use (1x) M10-1.50 x 60mm bolt, (2x) M10 washer and (1x) M10-1.50 lock nut. Put one washer on each side of the shock eyelet.

NOTE: On the right side, you will need to push the arm down to be able to reconnect the bottom of the shock.

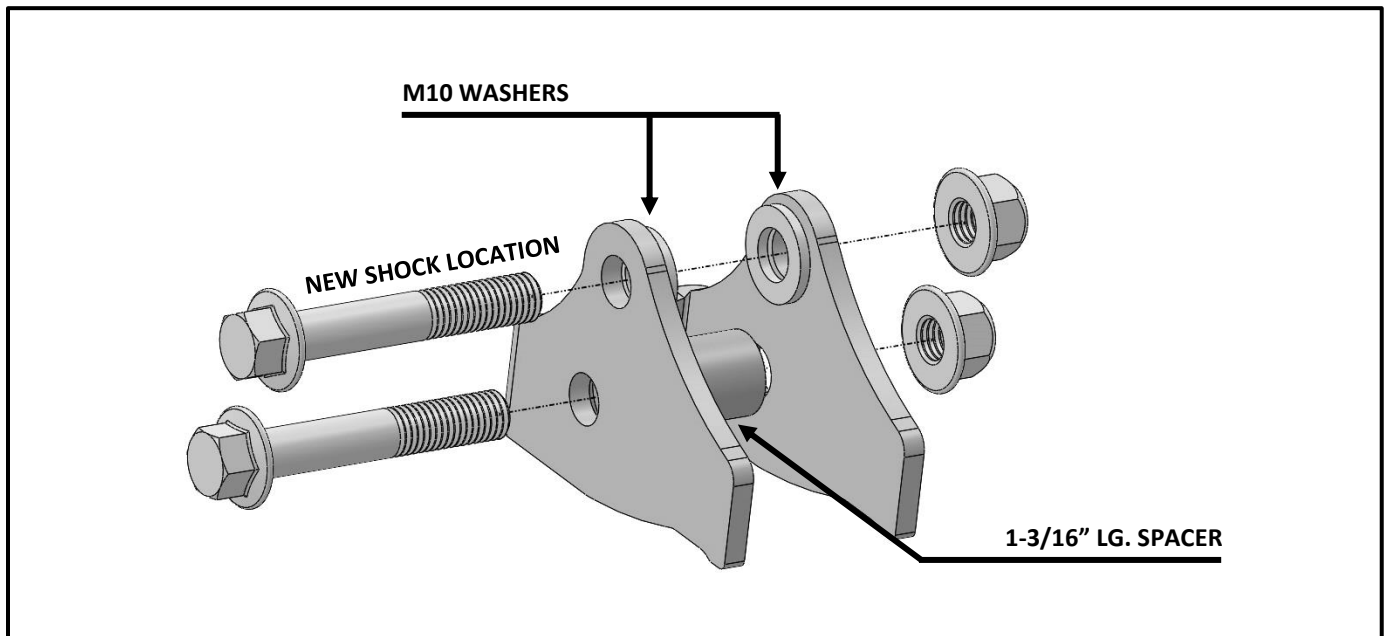
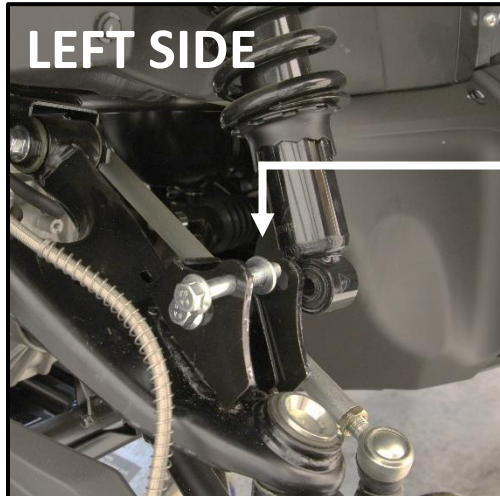

3. Tight all the hardware appropriately at this point. Use a 14mm and a 15mm wrench and socket.
4. Repeat the same steps for the opposite side.
5. Put the wheels back on the vehicle when the installation is finished. Torque all lugs to factory specification.

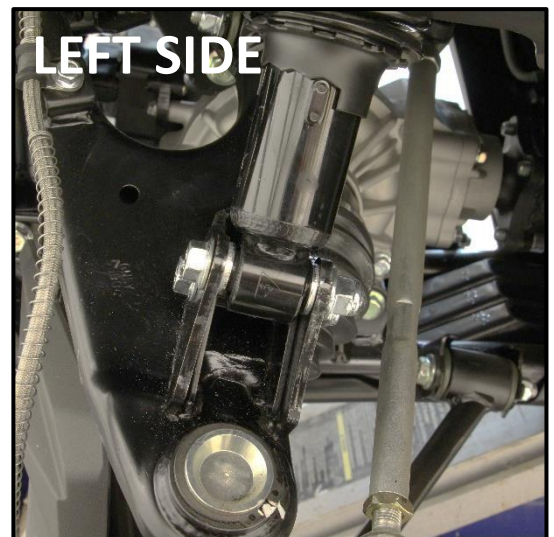

REAR INSTALLATION INSTRUCTIONS

PREPARATION

- Using a jack under center of rear end, lift until the rear wheels leave the ground.
- Remove the wheels.
- Disconnect the top of the shocks from the frame shock mount. Use a 15mm wrench and socket.

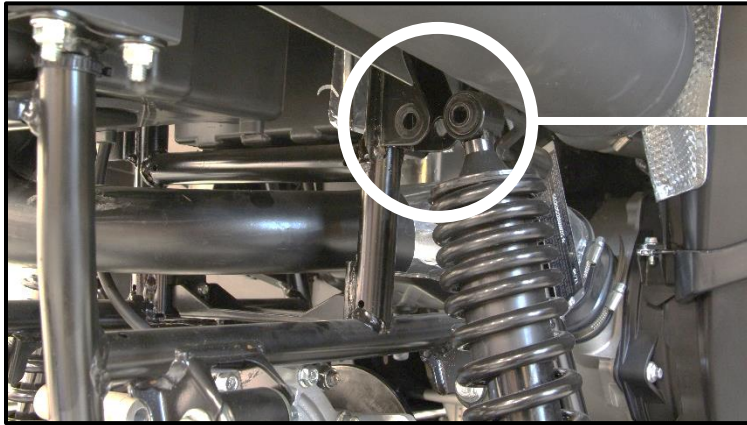

DISCONNECT BOTH SIDES

INSTALLATION

1. Insert the rear brackets to the frame shock mount. Put the bracket with the “PERFEX” logo face of the back of the ATV. Use (2x) M10x65mm bolt to fix them.

NOTE: The rear brackets must be installed on the **OUTSIDE** of the shock mount, not the inside.

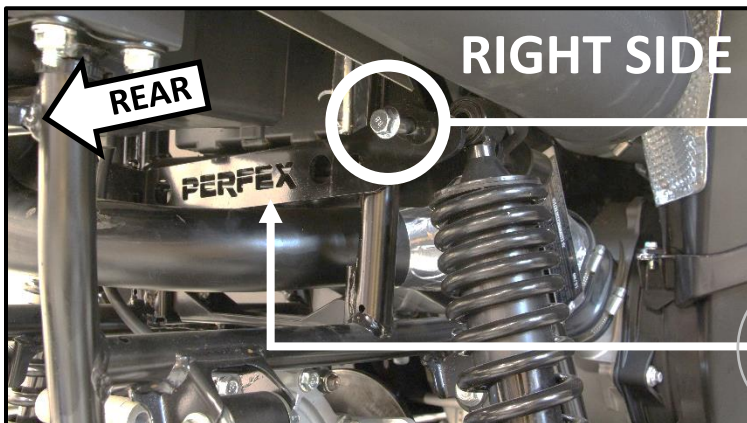

M10-1.50 x 65mm BOLT

03

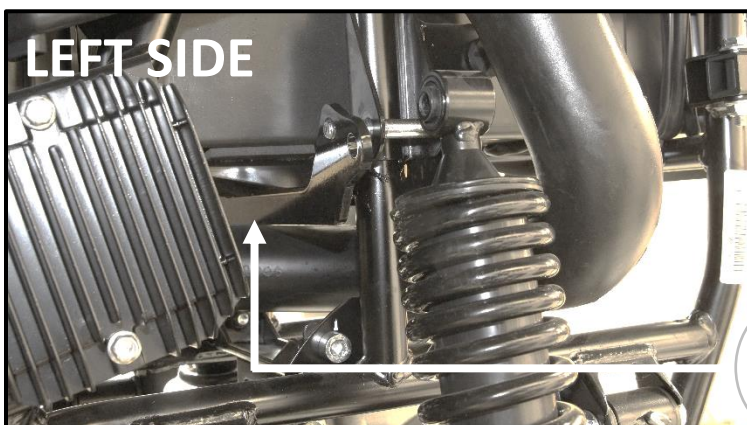

02

- Secure the bracket to the frame shock mount using **(2x)** 1-1/4" Lg. spacer and **(2x)** M10-1.50 lock nut. Put the spacers inside of the shock mount.

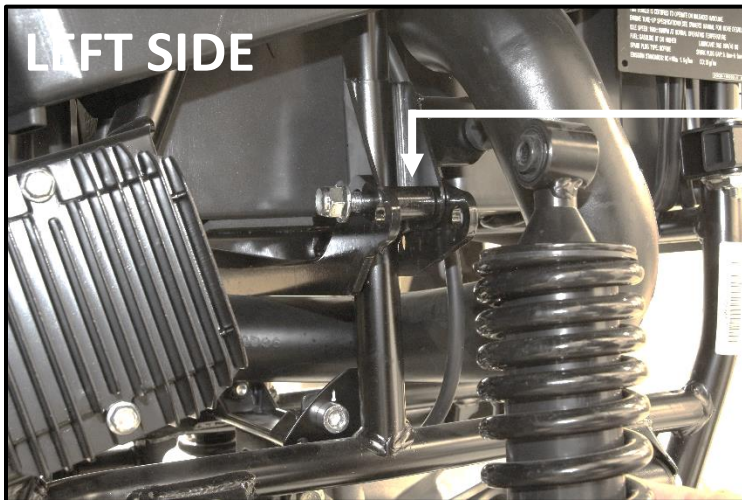

1-1/4" Lg. SPACER

- Connect the top of the shocks to the new shock location on the brackets. Use **(2x)** M10-1.50 x 65mm bolt, **(4x)** M10 washer and **(2x)** M10-1.50 lock nut. Put one washer on each side of the shocks eyelet.

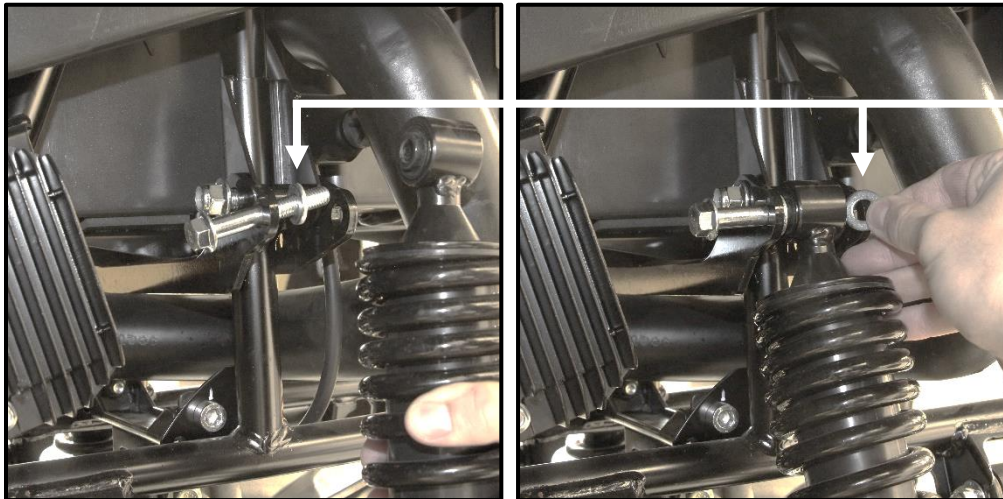

M10 WASHERS

- Tight all the hardware appropriately at this point. Use a 14mm and a 15mm wrench and socket.



- Put the wheels back on the vehicle when the installation is finished. Torque all lugs to factory specification.